



a trademark from

OMIT

STAND.MOVE

M1.4

Operating element for the STAND.CONTROL C1
Booking display for DEESK

Valid from firmware version 1.8.23

Contents

1	Preface	4
2	Explanation of terms and index of abbreviations	5
3	Safety	6
3.1	Purpose-conformant use of the product	6
3.2	Target group	6
3.3	Symbols used in the instructions	6
3.4	Safety instructions	7
3.4.1	General safety instructions	8
3.4.2	Safety instructions for resellers	10
3.5	Repairs	10
4	Warranty	11
5	Overview	12
6	Scope of delivery and necessary and optional accessories	13
6.1	Scope of delivery	13
6.2	Necessary accessories	13
6.3	DEESK accessories	13
6.4	Optional accessories	14
7	Installation	15
7.1	Unpacking	15
7.2	Installation	15
8	Commissioning	17
8.1	Commissioning the controller, general	17
8.2	Commissioning the STAND.MOVE M1.4	17
9	Operation	18
9.1	Display	18
9.2	Status of the WLAN connection	19
9.3	Status of a booking	19
9.4	Height-adjustment	20
9.5	Saving positions	20
9.6	Retrieving positions	21
9.7	Set and delete shelf and container stop	21
9.8	Menu	22
9.8.1	Activating or changing the menu pin number	24
9.8.2	F1 - Changing the unit of the height display (Inch – CM)	24
9.8.3	F2 - Calibrating the height display	25

9.8.4	F3 - Factory reset	25
9.8.5	F4/F5 - Set shelf and container stop	26
9.8.6	F6/F7 - Change the sensitivity of the internal SCC when moving up or down	27
9.8.7	F8/F9 - Change the sensitivity of the external sensor (STAND.GUARD G1) when moving upwards or downwards	28
9.8.8	F10 - Change the speed of the table	29
9.8.9	F11 - Change language	29
9.8.10	F12 - Query system information	30
9.8.11	F13 - Change or deactivate menu pin	30
9.8.12	F14 - Activate or deactivate BLE advertisement	31
9.8.13	F15 - Initiate restart.....	32
9.9	Automatic movement (configuration-dependant)	32
9.10	Cascading controllers	33
10	Disassembly / Maintenance.....	34
11	Maintenance	35
11.1	Cleaning and care.....	35
11.2	Visual codes	35
12	Technical data	39
13	Disposal	40
14	Additional information	41
14.1	Copyright	41
14.2	Licences.....	41
14.3	Trademarks.....	41
15	Address.....	42

1 Preface

Dear Customer,

we are pleased that you have decided to purchase our product. These operating instructions explain how to assemble, use and maintain this operating element. All operating elements are put through a function test and quality inspection before they leave our factory. Should you nonetheless have problems with your operating element, you can contact our service department at any time.

The operating element must be installed in accordance with these instructions. Any changes to the operating element or any improper usage can have an effect on the safety, functionality and service life.

These operating instructions have been written for the STAND.MOVE M1.4. Owing to different versions/types, the description may not be fully congruent with the illustrations.

Oelschläger **Metalltechnik** GmbH

2 Explanation of terms and index of abbreviations

Abb./Term	Meaning
OMT	Oelschläger Metalltechnik GmbH
DEESK	OMT trademark for smart office solutions
BLE	Bluetooth Low Energy - local communication protocol for mobile devices
WLAN	Wireless Local Area Network - communication protocol for Internet devices
SST	Sit-Stand Table
Steuerung	Control box of the SST (STAND.CONTROL C1)
Resetposition	Lowermost mechanical end position of the table
Minimalposition	Lowermost software end position of the table
Safety-Stopp	Stop position, from which onwards a safety zone up to the minimal position starts

3 Safety

This operating manual is to be preserved for future use. If a new copy nonetheless becomes necessary, it is available, during the expected service life of the described product, from Customer Service of Oelschläger **Metalltechnik** GmbH. Operating manuals of products that are currently being sold can be downloaded from the website of the manufacturer. The manufacturer's operating manual takes precedence and must be followed without fail.

3.1 Purpose-conformant use of the product

This operating element – also briefly called the handswitch in the following – has been developed for use on office desks in professional environments. Changes to the handswitch or domestic use are not permissible. Contravention will render the warranty null and void and void the liability of the manufacturer.

The handswitch must be assembled, put into operation and functionally checked by skilled personnel.

3.2 Target group

These operating instructions are aimed at the following group of persons:

- The commissioning staff who assembles and commissions the sit/stand desks.
- Furniture installers, maintenance staff who commission the sit/stand desk in sales rooms or at the final customer.

Knowledge of the following is a precondition for commissioning and installation of the operating element STAND.MOVE M1.4 in combination with the table controller STAND.CONTROL C1:



- Mechanical and electrical basic knowledge (a corresponding training)
- Reading the operating instructions

3.3 Symbols used in the instructions

Danger	Stands for an immediate, threatening danger. If not warded off, it will result in death or severe injuries.
Warning	Stands for a possibly threatening danger. If it is not avoided, death or very serious injuries may result.
Caution	Stands for a possibly threatening danger. If it is not avoided, light or minor injuries may result.
Note	Designates a possibly harmful situation. If it is not avoided, the plant or something in its surroundings can get damaged.



Warning of a source of danger.

Non-compliance with these warnings can result in harm to health, life-threatening injuries and property damage.



Warning of electrical voltage.

Non-compliance with these warnings can result in injuries and property damage!



Warning of injuries caused by crushing.

Non-compliance with these warnings can result in harm to health, life-threatening injuries and property damage.



Warning of damage from electrostatic discharge (ESD).



Indicates important information that must be observed for the safe operation of the product described.



Reference to the obligation to read the operating instructions.



Notice to pull out the power plug before the next activity.

3.4 Safety instructions

These operating instructions contain safety instructions that inform you about potential hazards and thus facilitate safe operation of the STAND.MOVE M1.4, in combination with the control box STAND.CONTROL C1. Please be sure you comply with these safety instructions!

This section provides you with general safety information that does not refer to any specific work step. You can find the job-specific safety instructions in the respective section of the operating instructions.

3.4.1 General safety instructions



Note: Please read and take note of, without fail, the operating manual before assembly/commissioning of the handswitch STAND.MOVE M1.4.



Danger: This unit can be used by children aged 8 years and above and by persons with reduced physical, sensory or mental capabilities or lack of experience and knowledge, if they are supervised or instructed in the safe use of the device and understand the resulting risks.



Danger: Children must not be allowed to play with the unit.



Danger: Unsupervised children must not carry out cleaning and user maintenance



Danger: You must disconnect the power supply cable from the mains supply before switching the hand switch and the controller on or off.



Caution: Use only hand switches from Oelschläger **Metalltechnik** GmbH only. The use of hand switches from third parties is prohibited! If unsuitable hand switches are used, damage or destruction of the controller can occur



Warning: If there is a fault (for example, unwanted movement of the table top if, for example, a button of the hand switch gets stuck), please immediately unplug the power cord.



Danger: Protect the hand switch from moisture, dripping water and spray water!



Danger: There is a danger of being crushed when the desktop position is changed. For this reason, make sure there are no objects or persons present in the danger zone and do not reach into the danger zone.



Attention: Modifications to the handswitch are strictly prohibited!



Danger: The safety collision mechanism is not activated during all reference drives. Watch out for the possible danger of being crushed.



Danger: The STAND.MOVE M1.4 must not be operated in potentially explosive atmospheres!



Danger: In case of a failure, it is possible that the desktop moves a bit during every start-up attempt before the safety shut-down comes into play. Watch out for the possible danger of being crushed.



Danger: If the product is visibly damaged, do not assemble it or continue to use it!



Note: When unpacking, ensure ESD-compliant handling of the electronic components.



Danger: Never immerse the handswitch, the control box or related cables in liquids and keep cables and devices away from heated surfaces.

3.4.2 Safety instructions for resellers

Resellers are companies that acquire the STAND.MOVE M1.4 from Oelschläger Metalltechnik GmbH and sell it on as their product.



Please note: For reasons of EU conformity and product safety, we recommend that you provide users of your products with operating instructions based on our template in the respective official language of the target country.



Please note: Be sure to enclose operating instructions in your finished product that include all safety instructions required by the consumer for the safe handling of your product.



Please note: The operating instructions for your end product must contain the following warning: *You must read the operating instructions before you start using the product.*

Point out to your end customers that the operating instructions must be kept in the immediate vicinity of the product.



Danger: It is mandatory that you put your product through a risk analysis so that you can react to any possible residual hazards (e.g. through structural measures or warnings in the operating instructions and/or safety instructions on your product).

3.5 Repairs



Caution: In order to avoid malfunctions, all repairs may only be carried out by authorized service personnel.



Caution: If the controller is opened, there is a risk of further malfunctions.

In case of a technical defect on the STAND.MOVE M1.4, please contact an authorised customer service representative from Oelschläger **Metalltechnik** GmbH.

4 Warranty

Oelschläger **Metalltechnik** GmbH provides a warranty for a period of 24 months for the STAND.MOVE M1.4 handswitch. The warranty covers all material and production errors and takes effect from the date of delivery. The warranty is only valid on the condition that the hand switch are assembled and used in an appropriate and technically correct manner within the framework of the parameters described, maintenance is carried out correctly, and repairs are only carried out by authorised service personnel.

STAND.MOVE M1.4 must not be incorrectly handled or used and no changes are permitted to be made to the handswitch; otherwise, the warranty expires. Please see our General Terms and Conditions of Business for more information.

Legal warranty or guarantee obligations remain unaffected by these regulations.

5 Overview

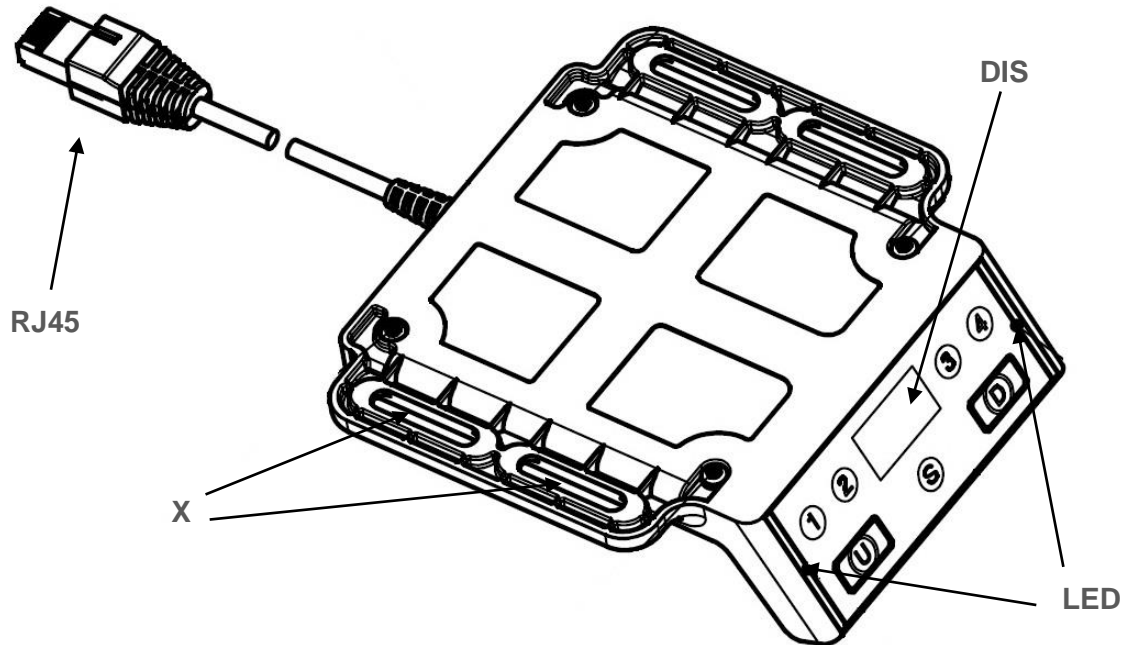

Figure 1: Representation of the STAND.MOVE M1.4 handswitch

- 1 Position button 1
- 2 Position button 2
- 3 Position button 3
- 4 Position button 4
- U UP button
- D DOWN button
- S Function button; Logo button
- DIS 128x64 OLED display with height, communication, booking and error displays
- LED Light strips (RGB)
- X Fastening with 4 screws / shifting of the controller possible (storage position)
- RJ45 RJ45 plug for the STAND.CONTROL C1 control box

6 Scope of delivery and necessary and optional accessories



Please note: Only the accessories listed and approved by OMT / DEESK may be used.



Caution: The connection of unapproved components / accessories can result in damage or malfunctions.

6.1 Scope of delivery

The delivery scope contains:

- STAND.MOVE M1.4

Other accessories required for operation can be obtained from OMT/DEESK.

6.2 Necessary accessories

At a minimum, the following accessories are necessary for an appropriate usage:

- STAND.CONTROL C1 control box
- CEE power cable with C8 plug (optionally also PVC / halogen-free)
- Table legs with electric drive
- Motor cable in the number of table legs to be connected (length depends on the table frame):
- STAND.CONNECT motor cable (optionally also PVC / halogen-free)
- Screws for mounting on the table top (see Section 7.2)

A two-motor table is generally implied in these operating instructions. All descriptions can be carried out in the same way with additional correctly connected accessories.

If a different configuration is required for a description in the operating instructions, this is explicitly indicated.

Large tables with more than two table legs (e.g. conference tables) also require:

- Additional STAND.CONTROL C1
- Connection cable: STAND.CONNECT connection cable

6.3 DEESK accessories

The following accessories are **additionally** required for communication between the STAND.MOVE M1.4 and the DEESK web platform:

- DEESK router (including SIM card for all of Europe) with power supply
- A DEESK web address for registering the virtual workstations

6.4 Optional accessories

Additional accessories are available to our customers for greater convenience:

- Motor cable extension (optionally also PVC / halogen-free)
- Various controllers: e.g. STAND.MOVE M1.0 or STAND.MOVE M1.1 (memory)
- Collision sensor STAND.GUARD G1
- RJ45 multi-plugs for expanding the number of device connections: STAND.CONNECT Hub
- Connection cable: STAND.CONNECT CC connection cable (USB communication between table and computer)
- LIVE.STAND: Software for Windows (Windows 10 and above) and app for iPhone (iOS 13 and above) for controlling the table and for a healthy sitting-standing-change reminder
- For DEESK, LIVE.STAND and additional RFID cards (MiFare Classic - 13.56 MHz) can support the proof of occupancy of the booked workstations

7 Installation

7.1 Unpacking



Note: When unpacking, ensure ESD-compliant handling of the electronic components.

Caution: Oelschläger **Metalltechnik** GmbH does not provide any warranty for faults and damage to the device that are the result of electrostatic discharge.

For unpacking electronic devices, please proceed as follows:

1. Remove the packaging material.
2. Check the contents of the package for completeness:
3. Dispose of the packaging material in an environment-friendly manner, in accordance with the applicable national regulations in your country. Recycle reusable packaging.

7.2 Installation

Assemble the control box STAND.CONTROL C1 in accordance with the relevant instructions. Install the operating element STAND.MOVE M1.4 on the front table edge on the underside of the table-top (see **Error! Reference source not found.**).

You will need the following material and tools for the installation:

- Pencil
- Drill
- 4 screws
- Screwdriver in a size suitable for the screws



Note: Before fitting, the control box and the handswitch must be electrically deenergised.



Note: The screws are not included in the scope of delivery since they have to be selected depending on the material and the thickness of the desktop.

There are holes with a diameter of 5.2 mm provided for this purpose on the hand switch. Use fillister-head or cheese-head screws.

The tightening torque depends on the desktop material, but should not exceed 2 Nm.

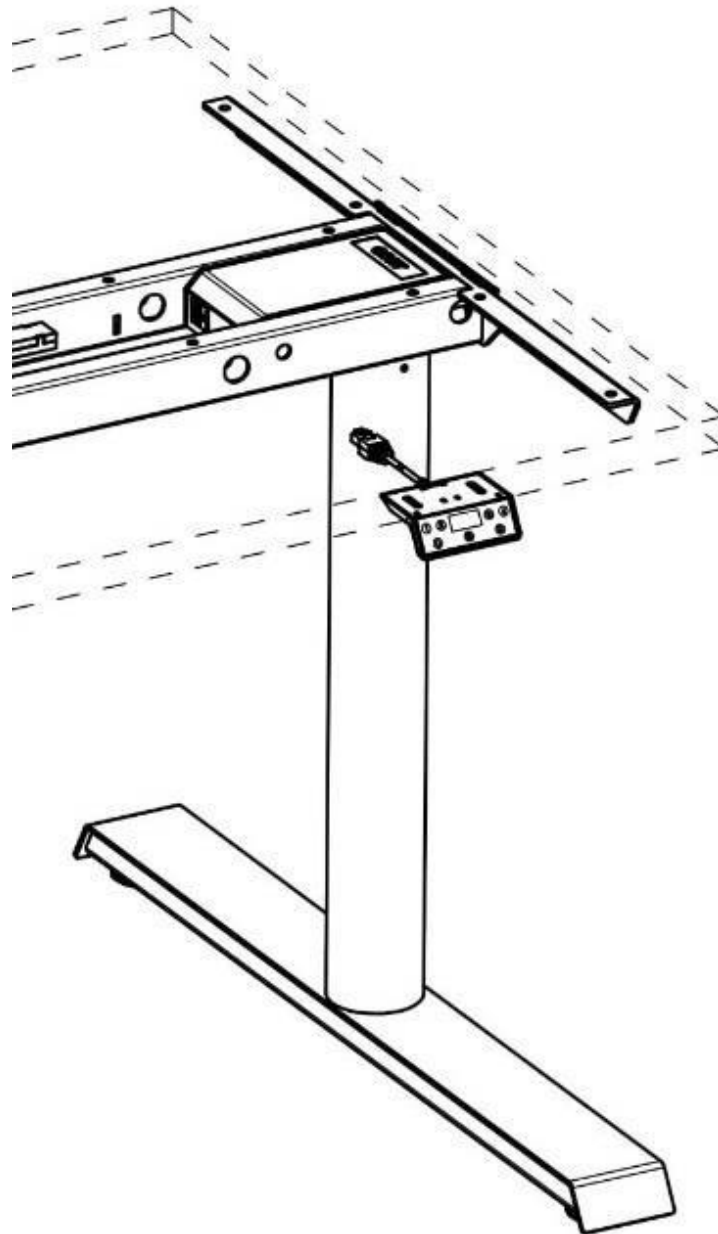

Figure 2: Position of the hand switch on the table-top (symbolic image)

For the installation, please carry out the following steps:

1. Position the operating element at the desired place on the table-top.
2. Mark the location of the drill holes with a pencil.
3. If required, pre-drill the marked locations for the screws using a drill.
4. Fasten the STAND.MOVE M1.4 with the 4 screws.

8 Commissioning



Note: Before commissioning, the controller and the handswitch must be electrically deenergised.

8.1 Commissioning the controller, general

STAND.MOVE M1.4 is used as the handswitch for the control box STAND.CONTROL C1. For the commissioning, please follow the operating manual of the STAND.CONTROL C1.

8.2 Commissioning the STAND.MOVE M1.4

Connect the handswitch with one of the RJ45 sockets (D1 or D2). Ensure that the RJ45 connector snaps into place audibly when it is connected. Verify correct fitting if required, by pulling on the cable with a small force.

If all the existing sockets are occupied, then with the help of a STAND.CONNECT hub and a STAND.CONNECT connecting cable, the existing connections can be expanded.

Only one STAND.MOVE M1.4 can be connected in parallel with another controller (**except STAND.MOVE M1.4**).



Warning: The table may only be operated by a person who is directly at the table and actively presses a button to do so.



Caution: After commissioning, accessory components must not be disconnected from the controller during movement. This can result in the table's unpredictable behaviour and is a danger to the user.



Please note: It is recommended that the table control be disconnected from the power supply before adding or replacing accessory components.

9 Operation



Figure 1: Handswitch STAND.MOVE M1.4

Oelschläger **Metalltechnik** GmbH offers its customers various types of STAND.MOVE M1.4. As a result, the appearance, the display, or the buttons can vary from the model in the illustration. All of our handswitch models are available with and without a printed logo. The functions that have been described can be executed with all these comfort hand switches and are described with the help of the model STAND.MOVE M1.4.



Caution: The upper end position of the desktop is pre-set in the controller. For this reason, only those controllers that have been supplied as being suitable for the respective desk base may be used.

In the operating manual of the STAND.CONTROL C1 controller, you will find a general description of the operation of the simple as well as comfort manual switches in conjunction with the control box.

9.1 Display

The hand switch has a 128x64px OLED-Display, from which the user can comfortably read the current height of the table-top and the system or booking status.

If the hand switch is not used for a prolonged period, the display gets turned off to save electricity. Press any button on the hand switch and the display gets turned on again.

If the display is showing numbers between 0 and 999, the height is being displayed in centimetres (cm). If the height display is set to inches, the point between the second and third digits is active.

Important error messages are displayed permanently and prevent the hand switch from going into power-saving mode so that the display goes off. All other errors are only displayed for as long as the hand switch is not in power-saving mode. These errors have the sole purpose of informing the user. After the display for taking note of the error, the controller is once again ready for operation.

9.2 Status of the WLAN connection

After the online registration of the controller, the STAND.MOVE M1.4 can show a booking status on the display. Communication between the controller and the web interface (e.g. a booking system) takes place via WLAN.



Figure 4: The WLAN symbol shows the communication status

The status of the WLAN connection is shown on the display: if the STAND.MOVE M1.4 does not find any known routers in the vicinity, an empty WLAN symbol is displayed.

If communication with a router is guaranteed without successful communication with a registered web interface (e.g. lack of internet), the WLAN symbol appears with an exclamation mark (!).

If both communication with the router via WLAN and communication with a web interface are functional, the complete WLAN symbol appears. As soon as the controller is registered with a booking system, the booking status of the associated workstation can be shown via the display and LEDs (green for free, yellow for booked and red for occupied).

The movement function of the controller and the operation of the menu are not influenced by the WLAN status. In the event that there is no communication, the table height or any error codes are displayed by default.

Communication via Bluetooth can be activated or deactivated via the menu. No symbol is shown for communication via Bluetooth.

9.3 Status of a booking

If communication with a router and a web interface are established, the STAND.MOVE M1.4 can be registered. An assigned virtual workstation then communicates with the controller and regularly reports its booking status.



Figure 5: The controller can display different booking statuses and LED colors

Depending on the booking status, the workstation can

- be free, the LEDs light up green and the name of the virtual workstation is shown on the display,
- be booked, the LEDs light up yellow and the name of the person responsible for this booking is shown on the display,
- or be occupied, the LEDs light up green* [*translator's note: should the light not be red in this case?] and the name of the person who checked in is shown on the display.

9.4 Height-adjustment



Note: When adjusting the height of the table, please ensure that no children or other persons are underneath the table. There is a risk of injury.

Press the -button to lower the desktop. Keep the button pressed until the desktop has reached the desired height. The table stops automatically as soon as the lower end position is reached (container-stop, safety stop or minimal position).

Press the -button to raise the desktop. Keep the button pressed until the desktop has reached the desired height. When the table reaches the upper end position or the pre-set shelf-stop, the movement is ended.

If there are already heights stored in the position memories, it is also possible to use the keys **1** - **4** for the height adjustment. In this context, see section 9.5.



9.5 Saving positions



Note: No positions can be saved below an existing container stop.

The STAND.CONTROL C1 controller provides the user the facility to save up to four heights. This function can only be used with a comfort hand switch. The positions are saved in the controller and are retained even when the hand switch is replaced.

To save a position, proceed as follows:

1. Move the table, using the arrow keys ( and ) to the desired height.
2. Press the “Logo” button below the display.
3. *Choose position* will appear on the display. The LEDs are blinking white.
4. Press the position key (keys **1** – **4**) to which you wish to save the position.
5. The selected position is shown on the display. The LEDs are turning green.

The current height is now ready to be retrieved using this position button. After approx. 2 seconds, the display toggles automatically and once again displays the current height. In this manner, a height can be assigned to every position button.

The saved positions cannot be deleted.

A saved position can be overwritten.

Position 1 is reserved for 'sitting' and position 2 for 'standing' by default for the LIVE.STAND ergonomic companion software.

9.6 Retrieving positions



Note: Stored functions below a newly created container stop and above a newly created shelf stop are ignored. In this case the table only moves to the container or shelf stop.

Keep the desired memory setting pressed (keys **1**–**4**). The desk independently moves from the current position to the saved position.

The button has to be pressed until the position is reached; if you let go beforehand, the desk stops moving.

9.7 Set and delete shelf and container stop



Warning: Only trained personnel should carry out setting and deletion of container and shelf stops. There is a danger of injury from wrong setting or removal of the Stop positions, and a danger of the table getting destroyed.



Note: This function is configuration-dependent and is not available with every controller.







Note: With the additional stops, the safety of the table system can be increased, in that the possible movement path is restricted.

Container- and shelf stops are safety positions that cannot be run over during normal operation, so that collisions with known, permanently present hindrances can be prevented. The container stop limits the movement height downwards (minimum height) and can be used if there are limiting factors below the table, for example, a Rollcontainer. The shelf stop limits the movement height of the table upward. The shelf stop can be used if there are limiting factors above the table, such as a shelf or the incline of a roof.



Setting the container stop is only possible in the lower half of the movement path of the table and only below the shelf stop.

Setting the shelf stop is only possible in the upper half of the movement path of the table and only above the container stop.

The procedure for setting the respective stop is identical. Proceed as follows:

1. Move the table, using the arrow keys ( and ) to the desired position.
2. Press both the arrow keys ( and ) at the same time.
3. The controller confirms with three “click-clack” sounds. The absence of this signal means that setting is possibly not permitted.

To delete the container stop, proceed as follows:

1. Keep the arrow key down  pressed.
2. The table stops automatically upon reaching the container stop.
3. Press both the arrow keys ( and ) at the same time.
4. The controller confirms with six “click-clack” sound.

Follow a similar procedure for deleting the shelf-stop.

1. Keep the arrow key up  pressed.
2. Steps 2 to 4 are identical to those for deleting the container stop.

If an attempt is made to set the container stop or shelf stop too close to the middle, the controller signals this with 6 “click-clack” sounds.

If the comfort hand switches such as the STAND.MOVE M1.4 are being used, there is an additional facility of setting and deleting container- and shelf stops through the menu. Instructions for the procedure can be found in section 9.8.4.



Warning: If an initialisation movement demanded by the controller is carried out, the Reset position is always taken up directly. Any container-stop or safety-stop that might be present is ignored.

First remove all hindrances below the table (for example, roll-containers) and be aware of the increased risk of injury.

9.8 Menu



Figure 6: After specifying the correct pin, the menu opens (example of the unit settings)

The STAND.MOVE M1.4 offers various setting options that can be made by the operator himself.

Hold down the "Logo" button for at least 6 seconds until the display changes. A pin may be requested, which can be changed or deactivated in the menu (F13 Menu - Menu Pin). By default, the pin value is 1111.

The menu is displayed directly or after specifying the correct pin and the light strips light up white. You can use the arrow keys to navigate through the menu (F for functions).

Structure of the menu:

F1	Unit	Change the unit of the height display (inch - cm)
F2	Height Calibration	Adjust the height display
F3	Reset	Reset to factory settings
F4	Shelf-Stop	Set shelf stop (limited, upper height)
F5	Container-Stop	Set container stop (limited, lower height)
F6	SCC Up	Change the sensitivity of the internal sensor when moving upwards (configuration-dependant)
F7	SCC Down	Change the sensitivity of the internal sensor when moving downwards (configuration-dependant)
F8	Sensor Up	Change the sensitivity of the external sensor when moving upwards (configuration-dependant)
F9	Sensor Down	Change the sensitivity of the external sensor when moving downwards (configuration-dependant)
F10	Speed	Change the speed of the table (configuration-dependant)
F11	Change Language	Change the language of the controller (DE <-> EN)
F12	Show System Information	Information about the serial number of the motor control and about the MAC address and firmware version of the controller
F13	Menu Pin	Change or deactivate the menu pin
F14	BLE Advertisement	Activate or deactivate Bluetooth communication
F15	Reboot	Restart of the controller after confirmation

Without a selection or further actions being made, the display automatically switches back to the booking display after approx. 10 s. If you select a menu option with the "Logo" button, you can carry out the selected settings; this is indicated by the flashing of the light bars. If no settings are made in the submenu for 10 s, the controller returns back to the booking display. All settings made in the submenus are permanently saved in the control system and are retained even if the controller is replaced.

9.8.1 Activating or changing the menu pin number

Press the „Logo“ button for at least 6 s until the handswitch displays a pin-request (if activated).

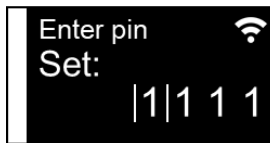

Default pin: „1111“

Only values between „1111“ and „4444“ are possible

The pin number can be activated or changed in the F13 Menu – Menu-PIN.

A pin entry is made by pressing the position keys (1 to 4) successively (pressing a key automatically switch to the next entry, the last entry being confirmed by pressing the final key). Entering a correct pin switch the display to the menu mode (LEDs will blink constantly white). Entering a wrong pin switch the display back to height and booking mode. After around 5 s, the display switches back automatically to height and booking mode.

Entering a pin can alternatively be done using the Up and Down buttons and confirming the selected number with the „Logo“ button until the fourth number. In that case, a valid pin will activate the menu mode.

9.8.2 F1 - Changing the unit of the height display (Inch – CM)

The height can be shown in centimetres or inches on the hand switch. The unit can be toggled in the menu. The height is displayed rounded to the nearest centimetres or in tenths of an inch with one decimal.

To change the unit, proceed as follows:

1. Go to the menu of the hand switch.
2. If necessary, enter the correct pin (default: 1111).
3. If necessary, navigate with the arrow keys (▼ and ▲) to menu function F1 (F1 Menu).
4. Confirm the selection by once again pressing the “Logo” key.
5. Now select the correct unit by pressing ▲ or ▼.
6. Confirm the selection by once again pressing the “Logo” key.
7. The handswitch automatically toggles back to the height and booking display.

The setting is permanently saved in the controller and is retained even when the hand switch is replaced. In the absence of any selection or further actions, after approx. 10 seconds, the display automatically switches back to the height and booking display.

9.8.3 F2 - Calibrating the height display

Sometimes, the comfort hand switch does not display the actual height of the desktop of your table. The reason for this can, for example, be the height-compensation using spacer discs below the table skids or the use of desktops of different thicknesses.

Retrospective settings can be made for this in the menu of the comfort hand switch.

To do this, proceed as follows:

1. Measure the correct current table height. Note the difference to the currently displayed table height.
2. Go to the menu of the hand switch.
3. If necessary, enter the correct pin (default: 1111).
4. If necessary, navigate with the arrow keys (⏪ and ⏩) to menu function F2 (*F2 Menu*).
5. Confirm the selection by once again pressing the “Logo” key. The height of the minimal position is displayed.
6. Adjust the displayed height with the arrow keys (⏪ and ⏩) by the noted difference, either up or down.
7. Confirm the input by once again pressing the “Logo” key.
8. The handswitch automatically toggles back to the height and booking display.

9.8.4 F3 - Factory reset



Note: All personal settings are reset. The memory positions are also reset when a factory reset is carried out. All settings are set back to the parameters related to the laser / label information on the control box.

If you wish to reset the controller to the factory settings because you do not wish to retain the changed settings, or notice an error, or were asked by a service employee from Oelschläger **Metalltechnik** GmbH to do so, proceed as follows:

1. Go to the menu of the hand switch.
2. If necessary, enter the correct pin (default: 1111).
3. If necessary, navigate with the arrow keys (⏪ and ⏩) to menu function F3 (*F3 Menu*).
4. Confirm the selection by once again pressing the “Logo” key.
5. Choose between NO / YES using the key ⏪ or ⏩.
6. Confirm the selection by once again pressing the “Logo” key.
7. The menu is exited automatically and **E38** is displayed. This code requests an initialization. Follow the instructions detailed under section 11.2 to complete the initialization by driving the table to its reference position (see also the manual of the control box STAND.CONTROL C1).

If no selection is made, after ten seconds, the display will automatically return to the main menu.

9.8.5 F4/F5 - Set shelf and container stop



Warning: Only trained personnel should carry out the setting of container and shelf stops. There is a danger of injury from wrong setting of the Stop positions, and a danger of the table getting destroyed.



Warning: With an initialisation movement prompted by the controller, the reset position is always taken up directly. Any container stop or safety stop that is present is ignored.

First, remove all hindrances below the table (for example, roller container) and pay heed to the increased risk of injury.



Note: Norms set the minimal distance from a potential obstacle to over 235 mm.



Note: With the additional stops, the safety of the table system can be increased, in that the possible movement path is restricted.

Container- and shelf stops are safety positions that cannot be run over during normal operation, so that collisions with known, permanently present hindrances can be prevented. The container stop limits the movement height downwards (minimum height) and can be used if there are limiting factors below the table, for example, a roll-container. The shelf stop limits the movement height of the table upward. The shelf stop can be used if there are limiting factors above the table, such as a shelf or the incline of a roof.

To set a container stop or a shelf stop, proceed as follows:

1. Use the arrow keys (⏏ and ⏏) to move to the desired position.
2. Go to the menu of the hand switch.
3. If necessary, enter the correct pin (default: 1111).
4. If necessary, navigate with the arrow keys (⏏ and ⏏) to menu function F4 (*F4 Menu*) for shelf-stop or to menu function F5 (*F5 Menu*) for container-stop.
5. Confirm the selection by once again pressing the “Logo” key.
6. Choose between saving or deleting the current saved position using the keys (⏏ and ⏏).
7. Confirm the selection by once again pressing the “Logo” key.

If no selection is made, after ten seconds, the display will automatically return to the main menu.

9.8.6 F6/F7 - Change the sensitivity of the internal SCC when moving up or down



Warning: Changing the sensitivity of the internal SCC collision protection should only be carried out by trained personnel. By reducing the sensitivity, collisions may be detected later or not at all.



Warning: The factory-set default values in the control system were selected so that the collision forces are below 150N for a maximum of 5 seconds and only 25N after the reversing movement. If the sensitivity is reduced, the EN ISO 13849-1 certification expires.







Note: This menu item is not available in all control system configurations. If the menu item is missing, the user is not allowed to change the sensitivity.



Note: Increasing the sensitivity can lead to false tripping.

To change the sensitivity of the internal collision protection for movement up or down, proceed as follows:

1. Go to the menu of the hand switch.
2. If necessary, enter the correct pin (default: 1111).
3. If necessary, navigate with the arrow keys ( and ) to menu function F6 (*F6 Menu*) for the SCC when moving upward or to menu function F7 (*F7 Menu*) for the SCC when moving downward.
4. Confirm the selection by once again pressing the “Logo” key.
5. Use the keys ( and ) to adjust the displayed sensitivity in % to the desired percentage:
 - a. 0% (OFF) tp
 - b. 99% (very sensitive)
6. Confirm the selection by once again pressing the “Logo” key.

If no selection is made, after ten seconds, the display will automatically return to the main menu.

9.8.7 F8/F9 - Change the sensitivity of the external sensor (STAND.GUARD G1) when moving upwards or downwards



Warning: Changing the sensitivity of the external SCC collision protection should only be carried out by trained personnel. By reducing the sensitivity, collisions may be detected later or not at all.



Warning: The factory-set default values in the control system were selected so that the collision forces are below 150N for a maximum of 5 seconds and only 25N after the reversing movement.



Note: This menu item is not available in all control system configurations. If the menu item is missing, the user is not allowed to change the sensitivity.







Note: This menu item is not available if there is no external sensor on the system.



Note: Increasing the sensitivity can lead to false tripping.

To change the sensitivity of the external collision protection for movement up or down, proceed as follows:

1. Go to the menu of the hand switch.
2. If necessary, enter the correct pin (default: 1111).
3. If necessary, navigate with the arrow keys ( and ) to menu function F8 (*F8 Menu*) for the upward direction or to menu function F9 (*F9 Menu*) for the downward direction.
4. Confirm the selection by once again pressing the “Logo” key.
5. Use the keys ( and ) to adjust the displayed sensitivity in % to the desired percentage:
 - a. 0% (OFF) tp
 - b. 99% (very sensitive)
6. Confirm the selection by once again pressing the “Logo” key.

If no selection is made, after ten seconds, the display will automatically return to the main menu.

9.8.8 F10 - Change the speed of the table



Note: Changing the speed should only be carried out by trained personnel.

To change the speed of the table, do the following:

1. Go to the menu of the hand switch.
2. If necessary, enter the correct pin (default: 1111).
3. If necessary, navigate with the arrow keys (⏪ and ⏩) to menu function F10 (*F10 Menu*).
4. Confirm the selection by once again pressing the “Logo” key.
5. Adjust the current speed in mm/s to the desired speed using the arrow keys (⏪ and ⏩):
 - a. 25mm/s (very slow) to
 - b. 50mm/s (very fast)
6. Confirm the selection by once again pressing the “Logo” key.

If no selection is made, after ten seconds, the display will automatically return to the main menu.

9.8.9 F11 - Change language

To change the language of the controller, proceed as follows:

1. Go to the menu of the hand switch.
2. If necessary, enter the correct pin (default: 1111).
3. If necessary, navigate with the arrow keys (⏪ and ⏩) to menu function F11 (*F11 Menu*).
4. Confirm the selection by once again pressing the “Logo” key.
5. Choose between *Deutsch* or *English* by pressing the keys (⏩ or ⏪).
6. Confirm the selection by once again pressing the “Logo” key.

If no selection is made, after ten seconds, the display will automatically return to the main menu.

9.8.10 F12 - Query system information



Note: The system information that can be called up via the STAND.MOVE M1.4 controller is required, for example, for registration with a booking system or for support measures.

Proceed as follows to read system information via the controller:

1. Go to the menu of the hand switch.
2. If necessary, enter the correct pin (default: 1111).
3. If necessary, navigate with the arrow keys (⏪ and ⏩) to menu function F12 (*F12 Menu*).
4. Confirm the selection by once again pressing the “Logo” key.
5. The following information is displayed by pressing the ⏪ or ⏩ key:
 - a *Motor serial number - Serial number of the control box of the STAND.CONNECT series, which controls the respective motors in the table columns.*
 - b *Mac address - Mac address of the wireless module of the STAND.MOVE M1.4 controller.*
 - c *Firmware version - current firmware version of the STAND.MOVE M1.4 controller.*
6. Confirm the selection by once again pressing the “Logo” key.

If no selection is made, after ten seconds, the display will automatically return to the main menu.

9.8.11 F13 - Change or deactivate menu pin



Warning: Changing the menu pin should only be carried out by trained personnel. A forgotten pin cannot be re-initialized.

To change the pin of the controller, proceed as follows:

1. Go to the menu of the hand switch.
2. If necessary, enter the correct pin (default: 1111).
3. If necessary, navigate with the arrow keys (⏪ and ⏩) to menu function F13 (*F13 Menu*).
4. Confirm the selection by once again pressing the “Logo” key.
5. Choose between *NO* / *YES* for activating (*YES*) or deactivating (*NO*) the pin by pressing the keys (⏪ or ⏩).
6. Confirm the selection by once again pressing the “Logo” key.

7. If **YES** is selected, the new pin can be entered using the memory buttons (1, 2, 3 and 4). Only values between „1111“ and „4444“ are possible. Confirm a value and end the entry by pressing the menu key.

If no selection is made, after ten seconds, the display will automatically return to the main menu.

9.8.12 F14 - Activate or deactivate BLE advertisement



Note: Moving a table via Bluetooth is only permitted via the LIVE.STAND App for iPhone.



Warning: Moving the table with the remote control increases the risk of injury. Pay special attention to the table and its surroundings while the table top is moving.

To change the BLE advertisement of the controller, proceed as follows:

1. Go to the menu of the hand switch.
2. If necessary, enter the correct pin (default: 1111).
3. If necessary, navigate with the arrow keys (⏪ and ⏩) to menu function F14 (*F14 Menu*).
4. Confirm the selection by once again pressing the “Logo” key.
5. Choose between *NO* / *YES* for activating (YES) or deactivating (NO) BLE advertisement by pressing the keys (⏪ or ⏩).
6. Confirm the selection by once again pressing the “Logo” key.

If no selection is made, after ten seconds, the display will automatically return to the main menu.

9.8.13 F15 - Initiate restart

To initiate a restart of the controller, proceed as follows:

1. Go to the menu of the hand switch.
2. If necessary, enter the correct pin (default: 1111).
3. If necessary, navigate with the arrow keys (⏪ and ⏩) to menu function F15 (*F15 Menu*).
4. Confirm the selection by once again pressing the “Logo” key.
5. Choose between *NO* / *YES* to either confirm (YES) or reject (NO) a restart by pressing the keys (⏪ or ⏩).
6. Confirm the selection by once again pressing the “Logo” key.

If no selection is made, after ten seconds, the display will automatically return to the main menu.

9.9 Automatic movement (configuration-dependant)

Warning: The automatic movement function is generally deactivated on delivery in Europe, as activation is not permitted in Europe (EN ISO 13849-1).



If the controller is being used within the scope of this standard, you must carry out a new evaluation in accordance with the specifications of EN 60335-1 and EN ISO 13849. Generally, according to the specifications of the standard, automatic movement is not permitted.

Oelschläger **Metalltechnik** GmbH is not liable for injuries or damage that may result from using the automatic movement function.



Note: Safety-related parts of the control systems were evaluated in accordance with EN ISO 13849-1 for PL b, Category B instead of EN 60335-1. This is permissible according to the "Experience exchange group in accordance with the decision of principle ZEK-GB-2004-04 (ZEK 40.2-04) EK5 / AK3 13-01:2018 Test principle for the safety and ergonomics of sitting / standing work tables" if only a push-to-run operation takes place (stops when you let go, no automatic operation), no remote control is used (e.g. Bluetooth, WLAN, USB, www, smartphone) and no timing control exists.



Warning: Automatic movement of the table increases the risk of injury. Pay special attention to the table and its surroundings while the table top is moving.

If automatic movement is activated in the controller, positions such as described in section 9.6 can be invoked by briefly pressing the relevant position key. The key does not have to be kept pressed the entire time. All other functions are identical.

Automatic movement is interrupted by pressing another key.

9.10 Cascading controllers

This STAND.MOVE M1.4 handswitch can be connected to any controller of a cascaded system.

It is not possible to connect two STAND.MOVE M1.4 to the same control box STAND.CONTROL C1. A STAND.MOVE M1.4 can otherwise be connected to a control box STAND.CONTROL C1 with a handswitch from the STAND.MOVE family with lower intelligence (simple UP/Down or Memory handswitch).

10 Disassembly / Maintenance

1. Remove any load from the tabletop.
2. Disconnect the controller from the mains.
3. Disconnect all the connections between the controller and the hand switch.
4. Dismantle the hand switch from the table.

11 Maintenance



Warning: Do not open the controller. Opening the controller will render all warranties from Oelschläger **Metalltechnik** GmbH null and void.



Danger: If you find defective cables, immediately isolate the controller from the mains. Pull the mains plug.

Check the plug-and-connector joints at the controller regularly for firm fitting. Check all the cables regularly for defects. If you find defective cables, plugs or loose plug-and-connector joints, replace the cables. If that is not possible, or does not bring about any improvement, contact the customer service from Oelschläger **Metalltechnik** GmbH.

11.1 Cleaning and care



Warning: Aggressive cleaning agents can cause damage or discolouration on the product. Therefore, only agents with a pH value of 6-8 may be used.

The Handswitch STAND.MOVE M1.1 can be wiped from the outside with a soft cloth. Coarse soiling may only be removed with a soft, damp cloth. Ensure that no moisture penetrates into the housing.



11.2 Visual codes

Visual codes are only visible on a handswitch from the STAND.MOVE family that includes a display (e. g. STAND MOVE M1.4).

Table 1: Visual codes of the control box.

Displayed code	Description	Remedy	Display after troubleshooting
C01	Short circuit motor 1	Disconnect the mains plug! Remove the external short circuit, check the cables to the motors for possible damage or plug the correct motor into the socket concerned. Put the controller back into operation.	Normal height display
C02	Short circuit motor 2		
C05	Relay contact is sticking	Replace the control system.	C38 - an initialization run is required
C11	Cable of motor 1 was pulled	Check the cable or plug connection to the motors.	C38 - an initialization run is required

Displayed code	Description	Remedy	Display after troubleshooting
C12	Cable of motor 2 was pulled		
C15	No pulses measurable	Check the cables to the motors for possible damage and secure contact or, if necessary, replace the correct motor at the relevant socket. Put the controller back into operation.	C38 - an initialization run is required
C34	Overcurrent on motor 1	Max. load exceeded. Remove the load from the table.	Normal height display
C35	Overcurrent on motor 2		
C38	The motors have lost sync. An initialization run is required	Motor positions too different. Distribute the load more evenly on the table. If necessary, reduce the load on the table. Perform an initialization run.	Normal height display

Displayed code	Description	Remedy	Display after troubleshooting
C39	Cascading error - a controller is not communicating	Check whether the STAND.CONNECT connection cable between the controllers is correctly plugged in and a power cable is plugged into both controllers.	Normal height display
		Use the F3 Menu to restore the factory settings in order to carry out a reconfiguration.	C38 - an initialization run is required
C40	Sensor module error	Further movements are carried out without collision protection. Movement remains possible. Check sensor module.	Normal height display after moving off in one direction
C51	Contradicting movement commands	Stop operation on all available controllers or similar.	Normal height display after moving off in one direction
C52	Key  is stuck on the controller	Replace the controller.	Normal height display
C53	Key  is stuck on the controller		
C81	Voltage too low	Can occur after disconnecting the power cord.	Normale Höhenanzeige nach Power-Up
		Power supply defective, replace controller.	C38 - an initialization run is required
C82	Voltage too high	Power supply defective, replace controller.	C38 - an initialization run is required
C84	No columns connected when the controller is switched on	First connect the desired number of columns and controller and restore the factory settings from the F3 Menu.	C38 - an initialization run is required
C85	Number of columns does not match the current configuration	Check the motor cables or use the F3 Menu to restore the factory settings.	C38 - an initialization run is required
REFERENCE	Initialization run should be carried out	Perform the initialization run to the lowest block position.	Normal height display
SYS.PROT.	System protection / system pause The system's duty cycle has been exceeded	Wait until the controller has cooled down and the SYS.PROT. display turns off. Then, the movement duration of 17 s is cleared. Only after 18 minutes does the table move again for a full 2 minutes. CAUTION! The duty cycle is calculated even if there is no mains voltage present.	Normal height display

Displayed code	Description	Remedy	Display after troubleshooting
COLLISION	Collision detected	Remove obstruction.	Normal height display after moving off in one direction
60-135	Table moves (height display)		

12 Technical data

The technical data of the STAND.MOVE M1.4 can be found below:

Dimension L/W/H:	123x124x32,5 mm
Color:	Standard = RAL 9005 (Black)
Fastening:	4x Screw max. \varnothing 5 mm
Cable length:	approx. 1500 mm
Connection:	RJ-45 fitting to the control box STAND.CONTROL C1
Rated input voltage:	9 - 31 V DC
Max. power consumption:	approx. 1,2 W
Radio protocols:	Bluetooth BLE 4.0, Wi-Fi (2.4 GHz, 802.11b/g/n), RFID (13,56 MHz)

13 Disposal

The FREE.STAND table-top support frame in which the STAND.MOVE 1.4 is fitted is an electrical and electronics device that must be disposed of separately from household waste, in accordance with the applicable WEEE-directive 2012/19/EU.

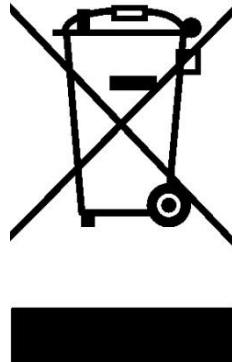

Figure 7: Identification markings for products in accordance with WEEE Directive 2012/19/EU

Dispose of the product and all other materials and parts in an environment-friendly manner, in accordance with the applicable national regulations in your country. Ensure that the disposal is sustainable for humans and nature.

Check for recyclability before disposal. As far as possible, take all the parts for recycling.

14 Additional information

14.1 Copyright

© January 2021 by Oelschläger **Metalltechnik** GmbH.

All rights reserved. All information in this operating manual is copyright-protected. No part of this operating manual may be copied or reproduced without the written consent of Oelschläger **Metalltechnik** GmbH. Oelschläger **Metalltechnik** GmbH reserves the right to make changes to the specifications and other information in this operating manual without prior notice.

14.2 Licences

After procurement and complete payment of the product, the customer may use the running texts and graphics in chapter **Error! Reference source not found.** for generating the end user documentation for the height-adjustable table, in which the STAND.MOVE M1.4 was integrated, for 10 years from delivery, free of charge. This licence does not include any logo, design or page layout elements of Oelschläger **Metalltechnik** GmbH. The customer may make all the necessary changes to the text and graphics to match them to the purpose of the end-user documentation. The texts and graphics may not be published or sub-licensed, either unchanged or modified, through the digital route. The transfer of this license to third parties without permission from Oelschläger **Metalltechnik** GmbH is also prohibited. The entire right of ownership and copyright to the text and graphics remains with Oelschläger **Metalltechnik** GmbH. The texts and graphics are offered as is, without any warranty or assurances of any kind.

Contact our customer service to get the text and graphics in an editable format.

14.3 Trademarks

Documentation can also contain, among other things, the depiction of registered trademarks of goods or services as well as information on copyright or other protected know-how of Oelschläger **Metalltechnik** GmbH or third parties. In all cases, all the rights remain exclusively with the respective holder.

15 Address

Oelschläger **Metalltechnik** GmbH

Hertzstraße 1-3

27318 Hoya – Germany

Tel.: +49 (0) 4251 – 816 – 0

Email: info@oelschlaeger.de

Internet: www.oelschlaeger.de

Registered office of the company: Hoya (Germany)

District Court of Walsrode - HRB 31030

CEO: Daniela Hoge | Harald Grams